

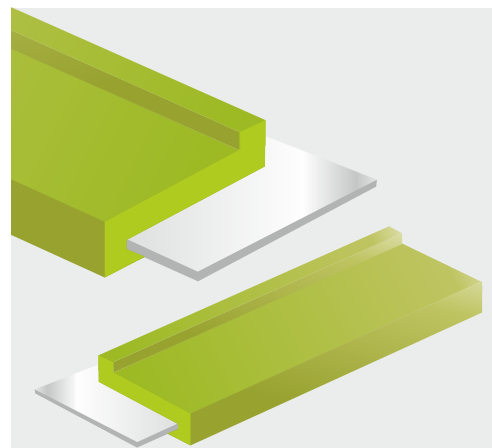

Perfiles Tipo Z
Profiles Type Z

LOS COLORES SON A MODO DE EJEMPLO.



Z 20

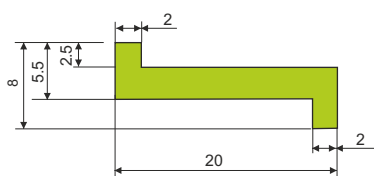

Z 22

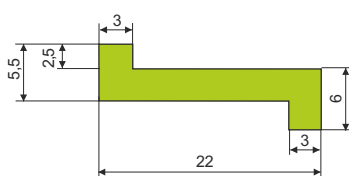

Z 23

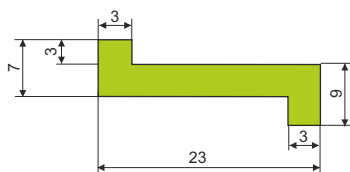

Z 25

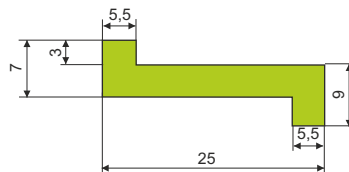

Z 27.5

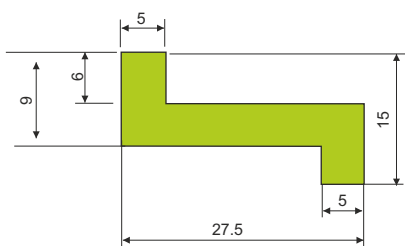

Z Clip

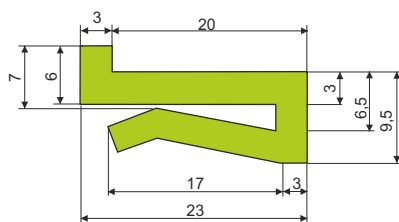

PARA PERFILES EN OTRAS
DIMENSIONES ENVIAR DETALLES

PIEZA	DESC.	PESO	PACK
222	Z-20	70 g	R
009	Z-22	80 g	
223	Z-23	115 g	
224	Z-25	120 g	
1428	Z-27.5	210 g	T
273	Z-CLIP	150 g	

REFERENCIAS	R-ROLLO T-TRAMO
VENTA	METRO
COLOR	EL COLOR DEL PERFILVARIA SEGÚN EL MODELO
MATERIALES	STD B2602 / V2600 / N2601
	OPCIONES A PEDIDO
	N - TERUAN 2820
	X - TEUVAX 1828
	E - ETADIM 1281

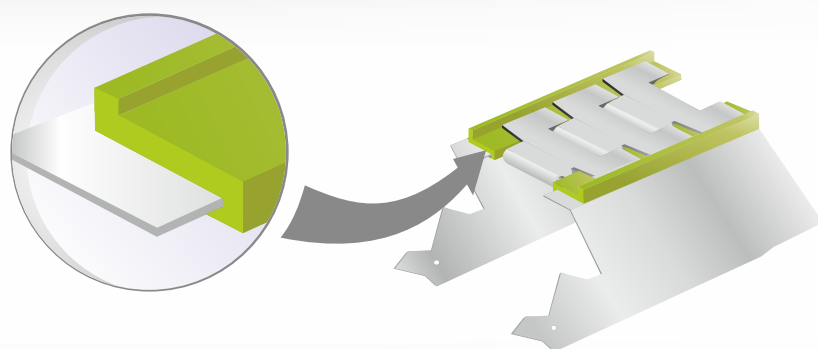

ESTOS PERFILES PUEDEN FABRICARSE EN
4 DIFERENTES CALIDADES:
THESE PROFILES CAN BE MANUFACTURED
IN 4 DIFFERENT QUALITIES:

Tipo L - Type L

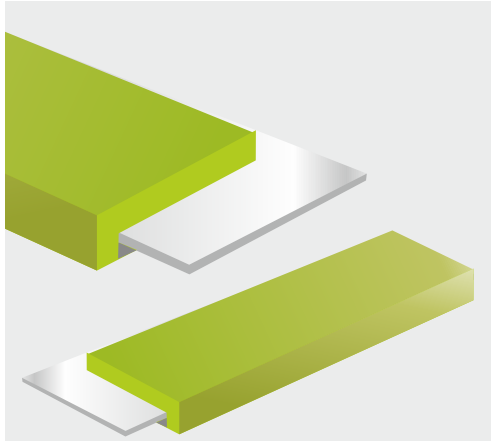

Perfiles Tipo L

Profiles Type L

LOS COLORES SON A MODO DE EJEMPLO.

PIEZA	DESC.	PESO	PACK
519	L-20	96 g	
1755	L-21	100 g	
230	L-22	75g	R
276	L-30	120 g	
234	L-40	129 g	
277	L-41	381 g	T

REFERENCIAS

R-ROLLO
T-TRAMO

VENTA

METRO

COLOR

EL COLOR DEL PERFIL VARIA
SEGÚN EL MODELO

MATERIALES

STD B2602 / V2600 / N2601

OPCIONES A PEDIDO

N - TERUAN 2820
X - TEUVAX 1828
E - ETADIM 1281

L 20

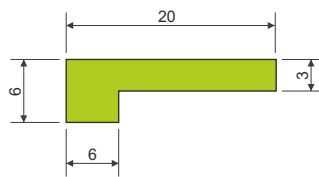

L 21

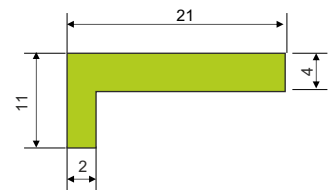

L 22

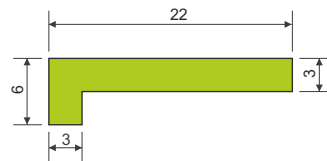

L 30

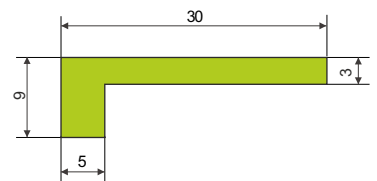

L 40

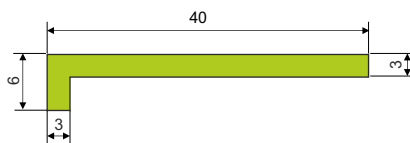

L 41

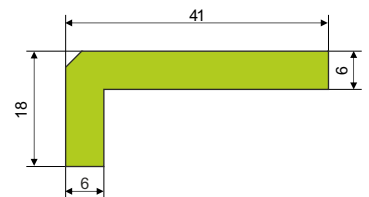

PARA PERFILES EN OTRAS
DIMENSIONES ENVIAR DETALLES

ESTOS PERFILES PUEDEN FABRICARSE EN
4 DIFERENTES CALIDADES:
THESE PROFILES CAN BE MANUFACTURED
IN 4 DIFFERENT QUALITIES:

Tipo L - Type L

Perfiles Tipo L Profiles Type L

LOS COLORES SON A MODO DE EJEMPLO.

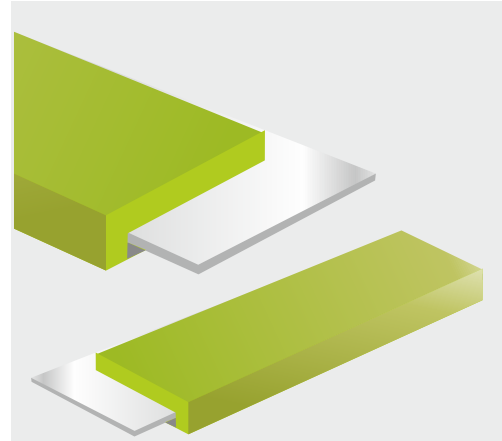

L 43

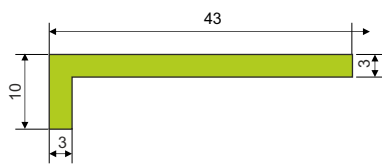

L Clip

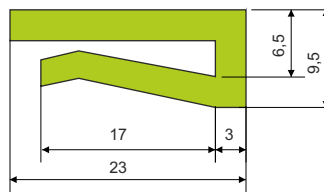

L 50

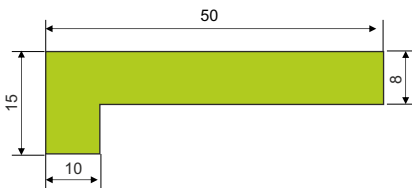

L 50x50

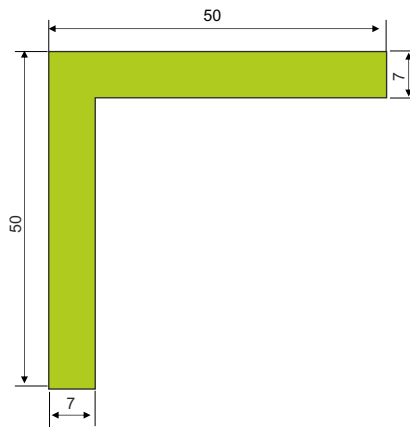

PARA PERFILES EN OTRAS
DIMENSIONES ENVIAR DETALLES

PIEZA	DESC.	PESO	PACK
232	L-43	150 g	R
1760	L-50	400 g	T
1761	L-50x50	651 g	
233	L-CLIP	142 g	R

REFERENCIAS	R-ROLLO T-TRAMO
VENTA	METRO
COLOR	EL COLOR DEL PERFILVARIA SEGÚN EL MODELO
MATERIALES	STD B2602 / V2600 / N2601
	OPCIONES A PEDIDO
	N - TERUAN 2820
	X - TEUVAX 1828
	E - ETADIM 1281

ESTOS PERFILES PUEDEN FABRICARSE EN
4 DIFERENTES CALIDADES:
THESE PROFILES CAN BE MANUFACTURED
IN 4 DIFFERENT QUALITIES:

Tipo C - Type C

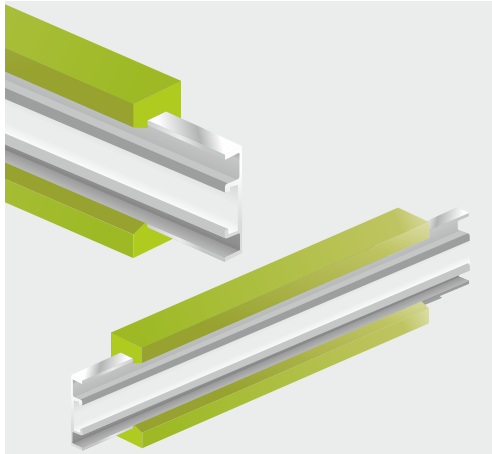

Perfiles Tipo C

Profiles Type C

LOS COLORES SON A MODO DE EJEMPLO.

PIEZA	DESC.	PESO	PACK
225	C-21	117 g	R
226	C-33	590 g	T
1743	C-40	240 g	
274	C-42	145 g	R
228	C-43	329 g	
275	C-52	340 g	
1790	C-52/80	400 g	T

REFERENCIAS	R-ROLLO T-TRAMO
VENTA	METRO
COLOR	EL COLOR DEL PERFIL VARIA SEGÚN EL MODELO
MATERIALES	STD B2602 / V2600 / N2601
	OPCIONES A PEDIDO N - TERUAN 2820 X - TEUVAX 1828 E - ETADIM 1281

C 21

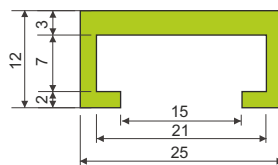

C 33

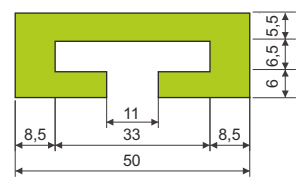

C 40

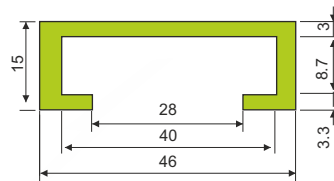

C 41 PERFIL DISCONTINUADO // REEMPLAZADO POR PERFIL C43

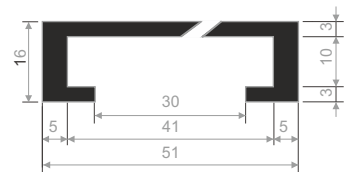

C 42

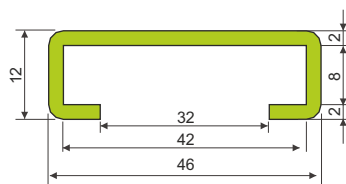

C 43

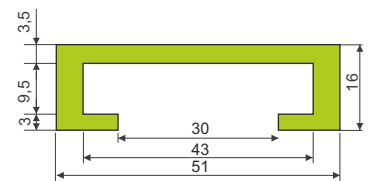

C 52

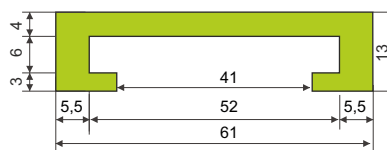

C 52/80

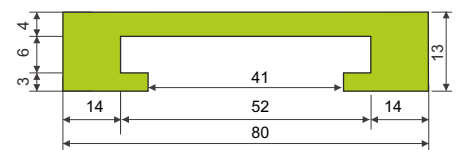

ESTOS PERFILES PUEDEN FABRICARSE EN 4 DIFERENTES CALIDADES:
THESE PROFILES CAN BE MANUFACTURED IN 4 DIFFERENT QUALITIES:

PARA PERFILES EN OTRAS DIMENSIONES ENVIAR DETALLES

Tipo C - Type C

Perfiles Tipo C Profiles Type C

LOS COLORES SON A MODO DE EJEMPLO.



C 82

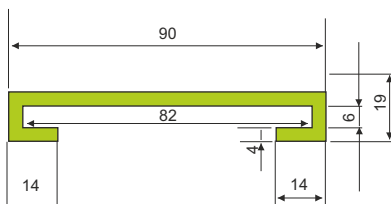

C 82 L

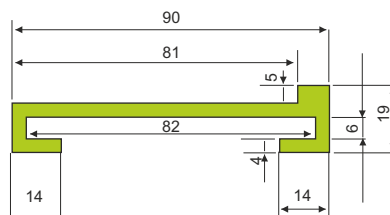

C Clip

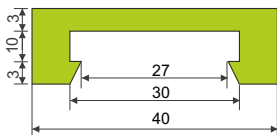

PERFIL AL. 50x6

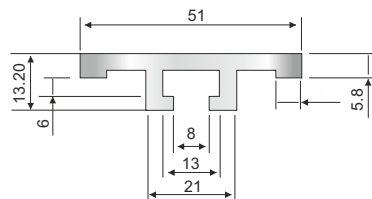

PARA PERFILES EN OTRAS
DIMENSIONES ENVIAR DETALLES

PIEZA	DESC.	PESO	PACK
1309	C-82	420 g	
1310	C-82 L	400 g	T
1255	AL	852 g	
229	C-CLIP	181 g	R

REFERENCIAS	R-ROLLO T-TRAMO
VENTA	METRO
COLOR	EL COLOR DEL PERFIL VARIA SEGÚN EL MODELO
MATERIALES	STD B2602 / V2600 / N2601
	OPCIONES A PEDIDO
	N - TERUAN 2820
	X - TEUVAX 1828
	E - ETADIM 1281

ESTOS PERFILES PUEDEN FABRICARSE EN
4 DIFERENTES CALIDADES:
THESE PROFILES CAN BE MANUFACTURED
IN 4 DIFFERENT QUALITIES:

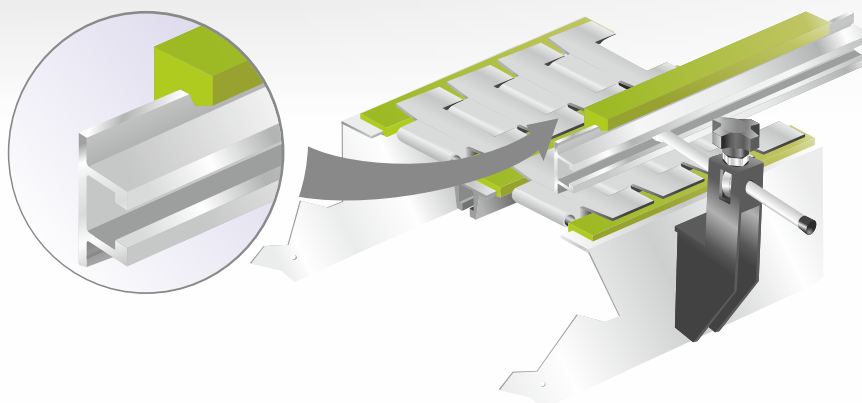

Tipo U - Type U

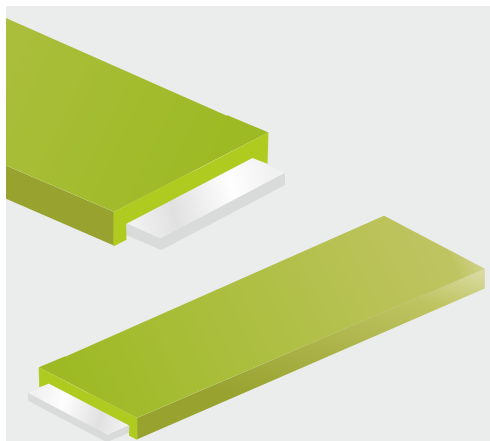

Perfiles Tipo U

Profiles Type U

LOS COLORES SON A MODO DE EJEMPLO.

PIEZA	DESC.	PESO	PACK
234	U-25	214 g	R
235	U-30,5	215 g	T
236	U-31	404 g	T
080	U-32	169 g	R
237	U-40/50	315 g	
238	U-50	206 g	
239	U-52	229 g	
240	U-58	300 g	

REFERENCIAS

R-ROLLO
T-TRAMO

VENTA

METRO

COLOR

EL COLOR DEL PERFIL VARIA
SEGÚN EL MODELO

MATERIALES

STD B2602 / V2600 / N2601

OPCIONES A PEDIDO

N - TERUAN 2820
X - TEUVAX 1828
E - ETADIM 1281

U 25

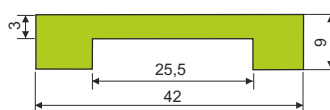

U 30,5

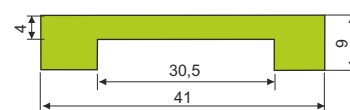

U 31

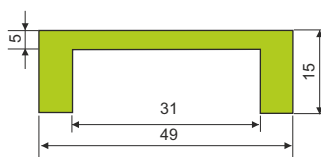

U 32

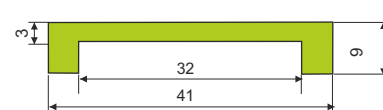

U 40-50

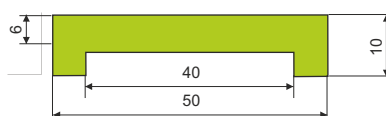

U 50

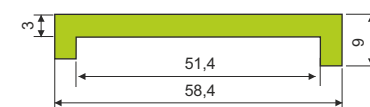

U 52

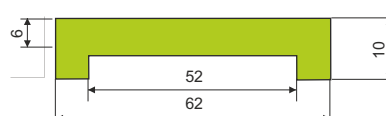

U 58

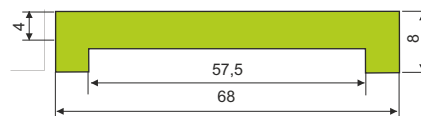

ESTOS PERFILES PUEDEN FABRICARSE EN
4 DIFERENTES CALIDADES:
THESE PROFILES CAN BE MANUFACTURED
IN 4 DIFFERENT QUALITIES:

PARA PERFILES EN OTRAS
DIMENSIONES ENVIAR DETALLES

Tipo U - Type U

Perfiles Tipo U Profiles Type U

LOS COLORES SON A MODO DE EJEMPLO.

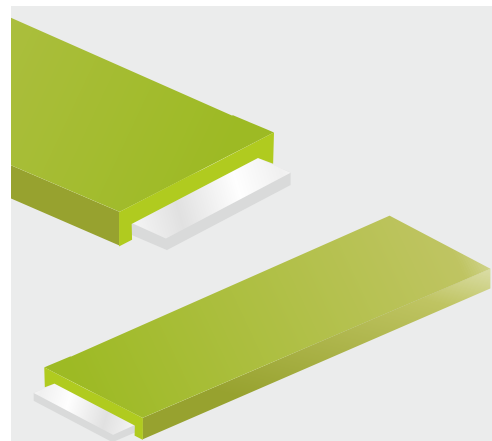

U 102

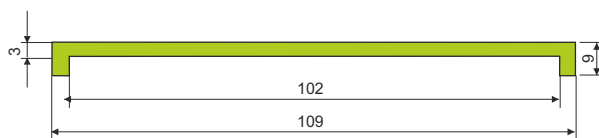

U 30,5x3

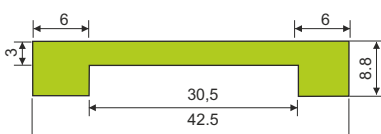

U Clip 28

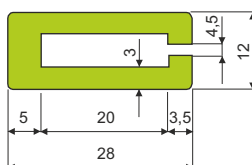

U Clip 26

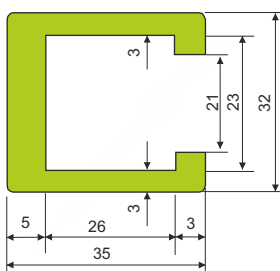

U Clip 35

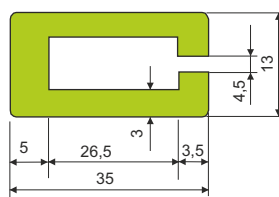

PARA PERFILES EN OTRAS
DIMENSIONES ENVIAR DETALLES

PIEZA	DESC.	PESO	PACK
241	U-102	410 g	R
244	U-Clip 28	200 g	
243			
969	U-Clip 26	390 g	T
968			
242	U-Clip 35	206 g	R
278			
1429	U 30.5x3	206 g	

REFERENCIAS	R-ROLLO T-TRAMO
VENTA	METRO
COLOR	EL COLOR DEL PERFILVARIA SEGÚN EL MODELO
MATERIALES	STD B2602 / V2600 / N2601
OPCIONES A PEDIDO	N - TERUAN 2820 X - TEUVAX 1828 E - ETADIM 1281

ESTOS PERFILES PUEDEN FABRICARSE EN
4 DIFERENTES CALIDADES:
THESE PROFILES CAN BE MANUFACTURED
IN 4 DIFFERENT QUALITIES:

Tipo U - Type U

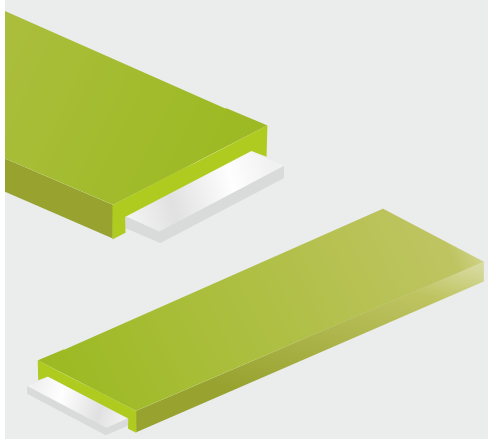

Perfiles Tipo U

Profiles Type U

LOS COLORES SON A MODO DE EJEMPLO.

U Clip 19

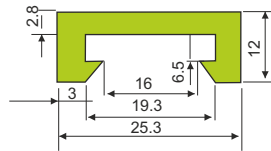

U Clip 32

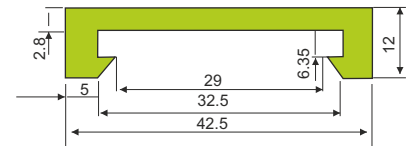

U Clip 30

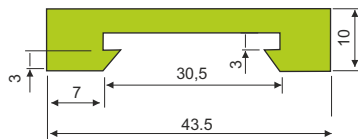

U AL 30x3

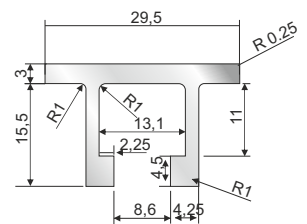

PARA PERFILES EN OTRAS
DIMENSIONES ENVIAR DETALLES

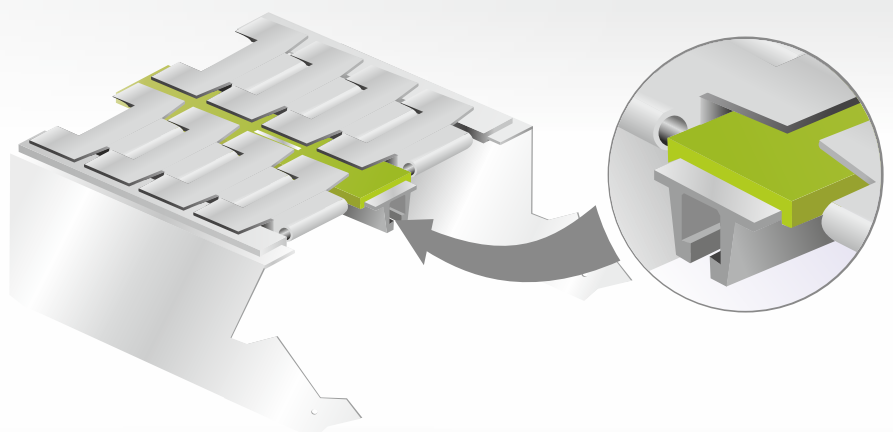

PIEZA	DESC.	PESO	PACK
1272	U-Clip 30	244 g	R
1270	AL 30x3	496 g	T
1426	U-Clip 19	140 g	R
1427	U-Clip 32	255 g	

REFERENCIAS	R-ROLLO T-TRAMO
VENTA	METRO
COLOR	EL COLOR DEL PERFIL VARIA SEGÚN EL MODELO
MATERIALES	STD B2602 / V2600 / N2601
OPCIONES A PEDIDO	N - TERUAN 2820 X - TEUVAX 1828 E - ETADIM 1281

ESTOS PERFILES PUEDEN FABRICARSE EN
4 DIFERENTES CALIDADES:
THESE PROFILES CAN BE MANUFACTURED
IN 4 DIFFERENT QUALITIES:

Tipo U - Type U

Perfiles Tipo U Profiles Type U

LOS COLORES SON A MODO DE EJEMPLO.

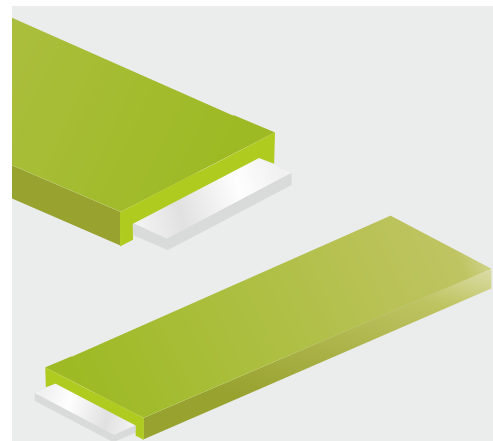

U 15x3,2

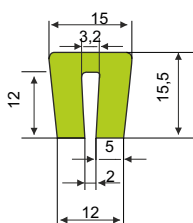

U 15x6

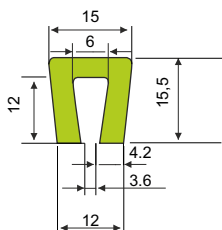

U Clip 33x14

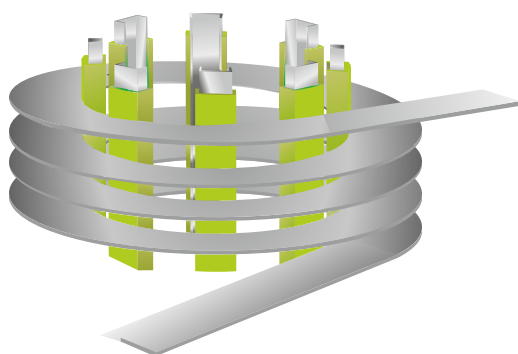
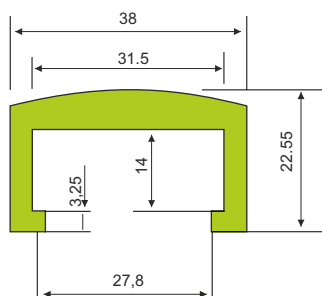

PARA PERFILES EN OTRAS
DIMENSIONES ENVIAR DETALLES

PIEZA	DESC.	PESO	PACK
1314	U-15x6	130 g	T
1315	U-15x3,2	200 g	
1351	U-Clip 33x14	160 g	

REFERENCIAS	R-ROLLO T-TRAMO
VENTA	METRO
COLOR	EL COLOR DEL PERFILVARIA SEGÚN EL MODELO
MATERIALES	STD B2602 / V2600 / N2601
OPCIONES A PEDIDO	N - TERUAN 2820 X - TEUVAX 1828 E - ETADIM 1281

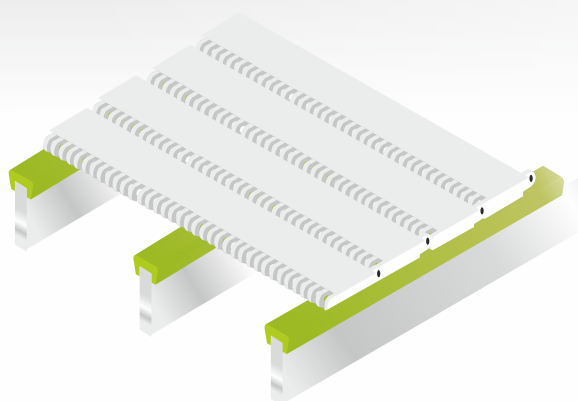

ESTOS PERFILES PUEDEN FABRICARSE EN
4 DIFERENTES CALIDADES:
THESE PROFILES CAN BE MANUFACTURED
IN 4 DIFFERENT QUALITIES:

Tipo UT - Type UT

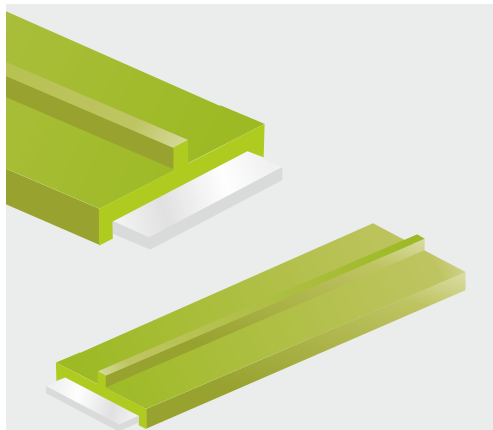

Perfiles Tipo UT

Profiles Type UT

LOS COLORES SON A MODO DE EJEMPLO.

PIEZA	DESC.	PESO	PACK
245	UT 32	165 g	R
279	UT 34	170 g	
079	UT 38	185 g	
246	UT 39	193 g	
247	UT 41	157 g	
248	UT 45	268 g	

UT 32

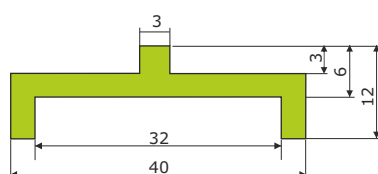

UT 34

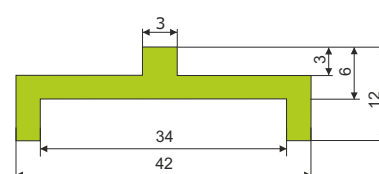

UT 38

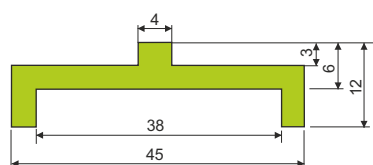

UT 39

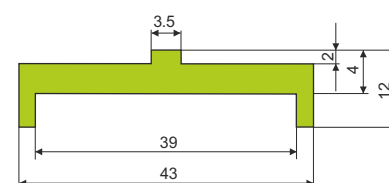

UT 41

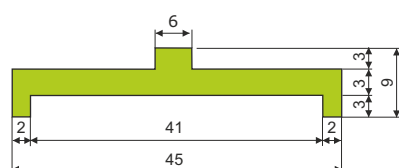

UT 45

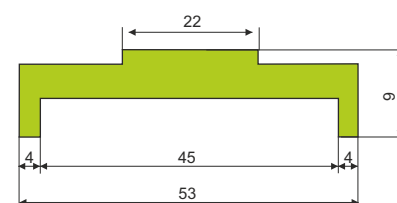

PARA PERFILES EN OTRAS
DIMENSIONES ENVIAR DETALLES

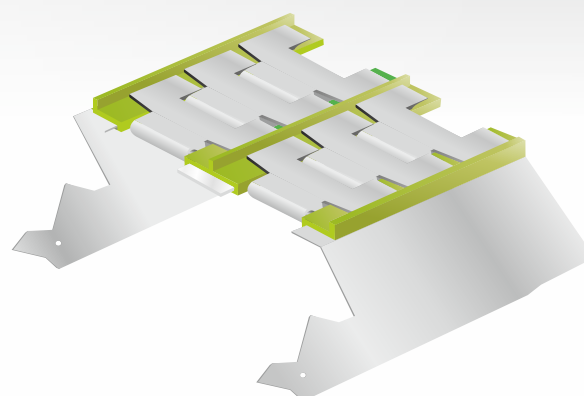

ESTOS PERFILES PUEDEN FABRICARSE EN
4 DIFERENTES CALIDADES:
THESE PROFILES CAN BE MANUFACTURED
IN 4 DIFFERENT QUALITIES:

Tipo UT - Type UT

Perfiles Tipo UT
Profiles Type UT

LOS COLORES SON A MODO DE EJEMPLO.

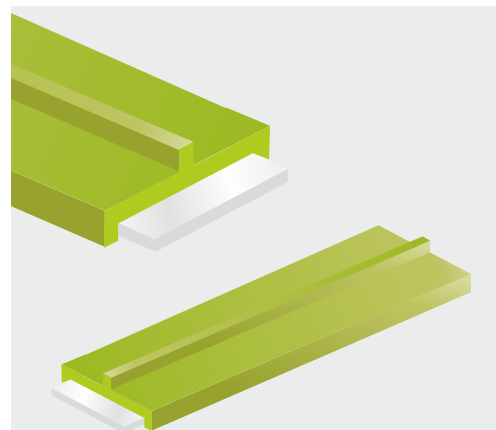

PISTA UT CLIP 30

AL 30x3

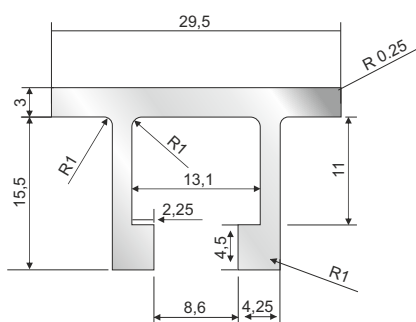
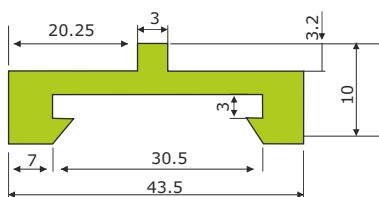

PARA PERFILES EN OTRAS
DIMENSIONES ENVIAR DETALLES

PIEZA	DESC.	PESO	PACK
1271	U-Clip 30	253 g	R
1270	AL. 30x3	496 g	T

REFERENCIAS	R-ROLLO T-TRAMO
VENTA	METRO
COLOR	EL COLOR DEL PERFIL VARIA SEGÚN EL MODELO
MATERIALES	STD B2602 / V2600 / N2601
OPCIONES A PEDIDO	N - TERUAN 2820 X - TEUVAX 1828 E - ETADIM 1281

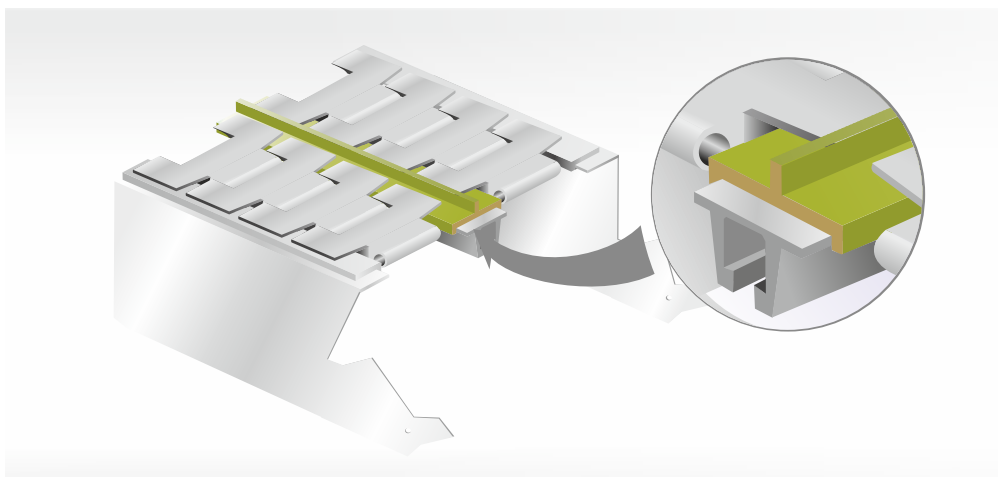

ESTOS PERFILES PUEDEN FABRICARSE EN
4 DIFERENTES CALIDADES:
THESE PROFILES CAN BE MANUFACTURED
IN 4 DIFFERENT QUALITIES:

Tipo T/F - Type T/F

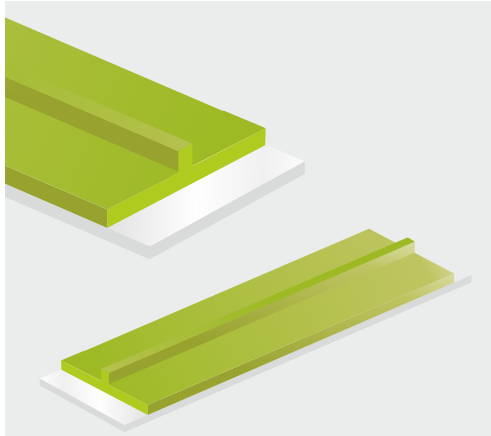

Perfiles Tipo T/F

Profiles Type T/F

LOS COLORES SON A MODO DE EJEMPLO.

T 40

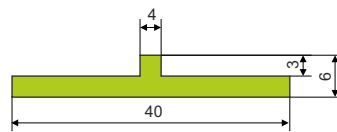

T 52

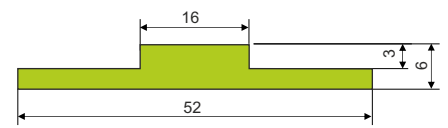

PIEZA	DESC.	PESO	PACK
252	T40	129 g	R
253	T52	191 g	
280	F COMÚN	412 g	T
081	F ESPECIAL	308 g	

REFERENCIAS

R-ROLLO
T-TRAMO

VENTA

METRO

COLOR

EL COLOR DEL PERFIL VARIA
SEGÚN EL MODELO

MATERIALES

STD B2602 / V2600 / N2601

OPCIONES A PEDIDO

N - TERUAN 2820
X - TEUVAX 1828
E - ETADIM 1281

F ESPECIAL

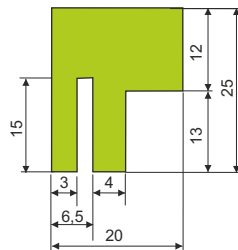

F COMÚN

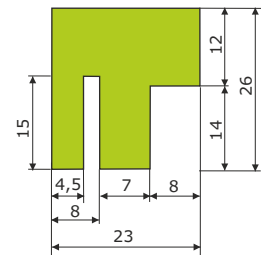

PARA PERFILES EN OTRAS
DIMENSIONES ENVIAR DETALLES

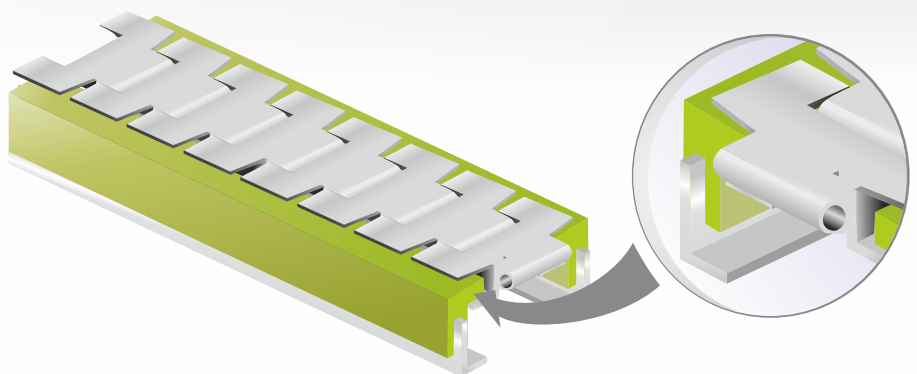

ESTOS PERFILES PUEDEN FABRICARSE EN
4 DIFERENTES CALIDADES:
THESE PROFILES CAN BE MANUFACTURED
IN 4 DIFFERENT QUALITIES:

Tipo Uπ - Type Uπ

Perfiles Tipo Uπ Profiles Type Uπ

LOS COLORES SON A MODO DE EJEMPLO.

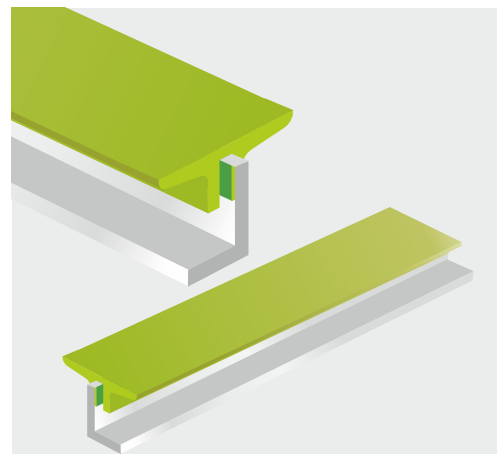

Uπ 18 Negro

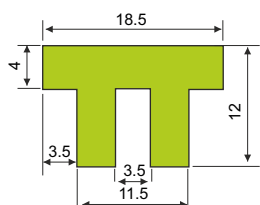

Uπ 40

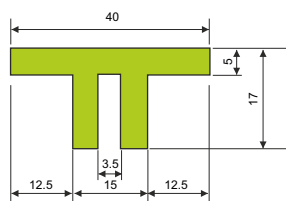

Uπ 40 con GUIA

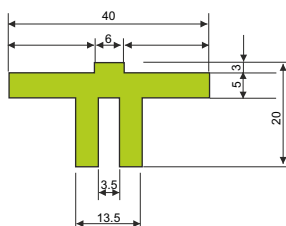

Uπ 35

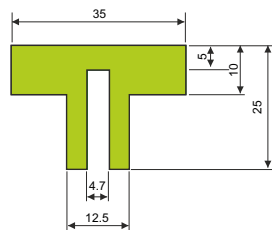

Uπ 45

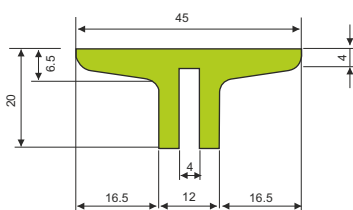

Uπ 45 LATERAL

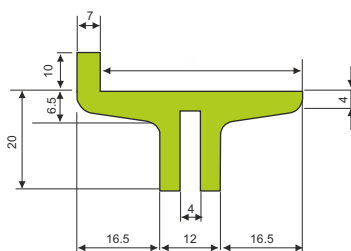

PIEZA	DESC.	PESO	PACK
1441	18	140 g	T
989	Uπ 40	350 g	
990	Uπ 40 C/GUÍA	344 g	
1243	Uπ 35	430 g	
993	Uπ 45	390 g	
1091	Uπ 45 LATERAL	420 g	

REFERENCIAS	R-ROLLO T-TRAMO
VENTA	METRO
COLOR	EL COLOR DEL PERFILVARIA SEGÚN EL MODELO
MATERIALES	STD B2602 / V2600 / N2601
OPCIONES A PEDIDO	N - TERUAN 2820 X - TEUVAX 1828 E - ETADIM 1281

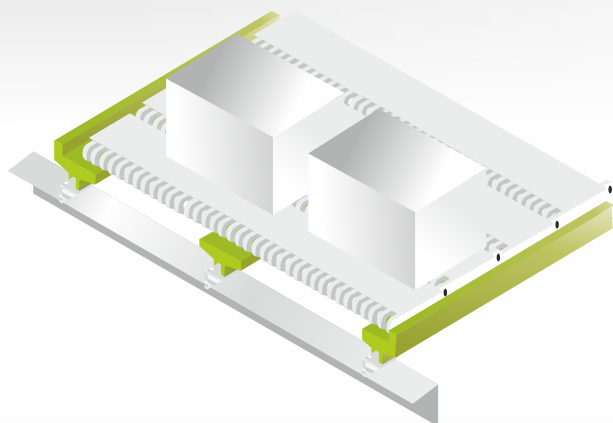

ESTOS PERFILES PUEDEN FABRICARSE EN 4 DIFERENTES CALIDADES:
THESE PROFILES CAN BE MANUFACTURED IN 4 DIFFERENT QUALITIES:

Tipo D - Type D

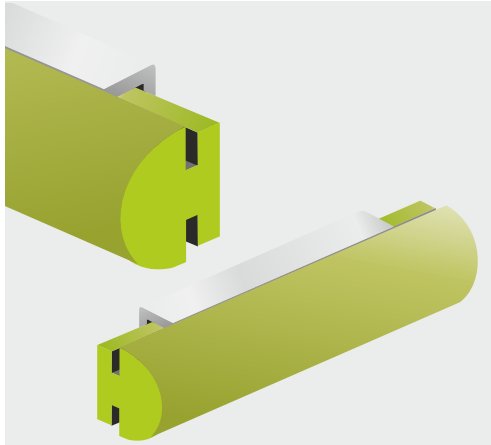

Perfiles Tipo D

Profiles Type D

LOS COLORES SON A MODO DE EJEMPLO.

PIEZA	DESC.	PESO	PACK
1440	DOBLE 40	500 g	T
1411	DOBLE 38.5	500 g	
010	D12	290 g	
1001	D10	230 g	
1002	D HUECO	90 g	
517	BARANDA C5	560 g	

D DOBLE 40x8

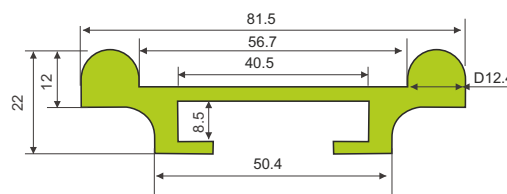

D DOBLE 6.35x38.1

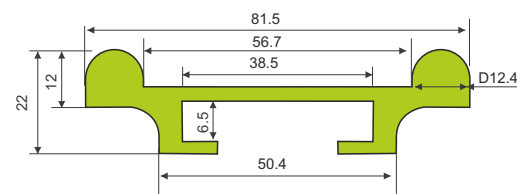

D 10

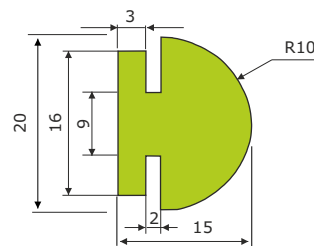

D 12

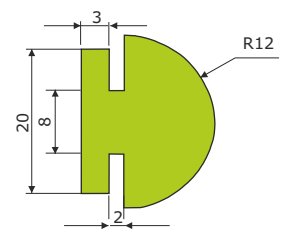

C5 INOXIDABLE

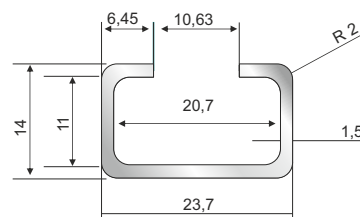

D HUECO

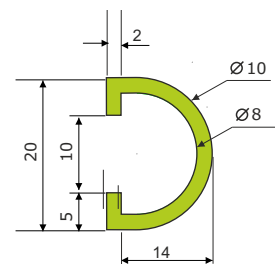

REFERENCIAS

R-ROLLO
T-TRAMO

VENTA

METRO

COLOR

EL COLOR DEL PERFIL VARIA
SEGÚN EL MODELO

MATERIALES

STD B2602 / V2600 / N2601

OPCIONES A PEDIDO

N - TERUAN 2820
X - TEUVAX 1828
E - ETADIM 1281

ESTOS PERFILES PUEDEN FABRICARSE EN
4 DIFERENTES CALIDADES:
THESE PROFILES CAN BE MANUFACTURED
IN 4 DIFFERENT QUALITIES:

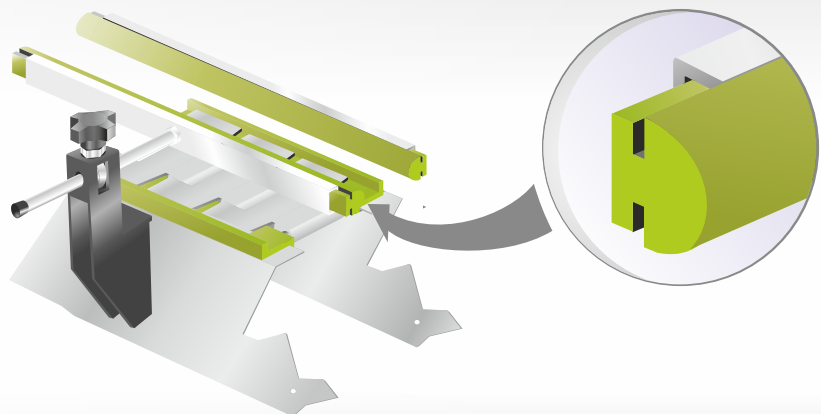

Neumático - Neumatic

Perfiles Tipo Guía Neumático Profiles Type Neumatic Transport Profile

LOS COLORES SON A MODO DE EJEMPLO.



GUÍA NEUMÁTICA 24x10

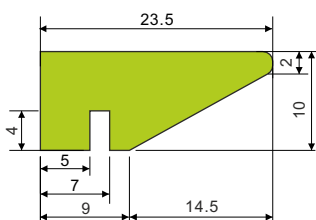

GUÍA NEUMÁTICA 32x12

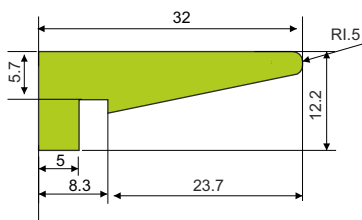

PIEZA	DESCRP.	PESO	PACK
249	G. NEUM. 24x10	412 g	R
1408	G. NEUM. 32x12	630 g	T
1090	G. NEUM. C10.6x1.8	38 g	R
1005	ALUM. C/GUÍA NEU.	132 g	
1352	G. NEUM. C PLANO	38 g	T
1178	G. NEUM. RECTO	70 g	

ALUM. C/GUÍA NEUMAT. ENCASTRE CÓNICO

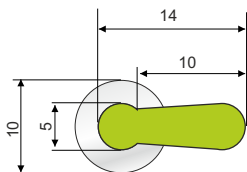

GUÍA NEUM. C PLANO

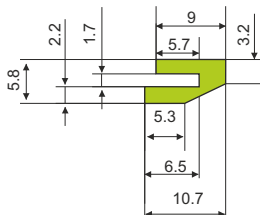

GUÍA NEUMÁTICO ENCASTRE RECT.

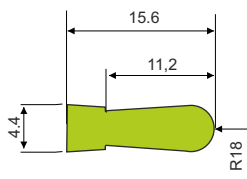

PERFIL DISCONTINUADO REEMPLAZADO POR GUÍA NEUMÁTICA C PLANO

GUÍA NEUM. C10.6x1.8

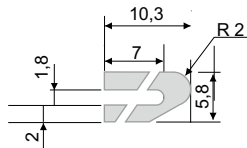

PARA PERFILES EN OTRAS
DIMENSIONES ENVIAR DETALLES

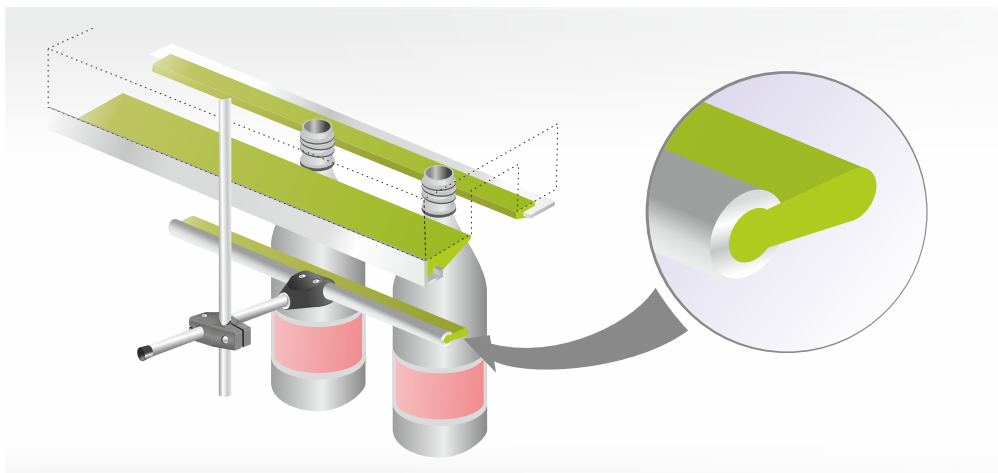

REFERENCIAS	R-ROLLO T-TRAMO
VENTA	METRO
COLOR	EL COLOR DEL PERFILVARIA SEGÚN EL MODELO
MATERIALES	STD B2602 / V2600 / N2601
OPCIONES A PEDIDO	N - TERUAN 2820 X - TEUVAX 1828 E - ETADIM 1281

ESTOS PERFILES PUEDEN FABRICARSE EN
4 DIFERENTES CALIDADES:
THESE PROFILES CAN BE MANUFACTURED
IN 4 DIFFERENT QUALITIES:

Baranda - Side Guide

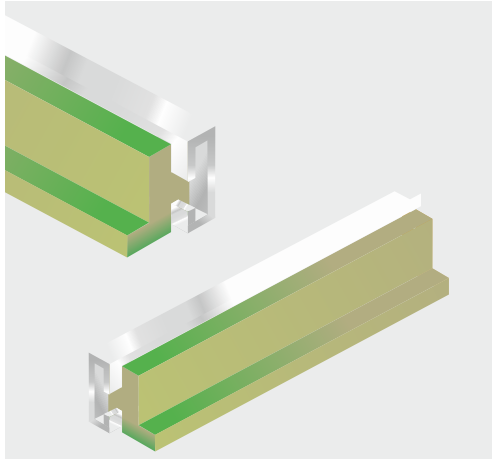

Perfiles Baranda Plana

Side Guide

LOS COLORES SON A MODO DE EJEMPLO.

GUÍA 24x12

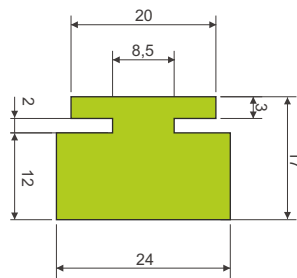

GUÍA 24x6

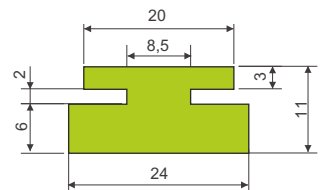

C 5

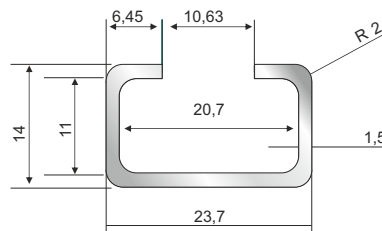

GUÍA 24x6L

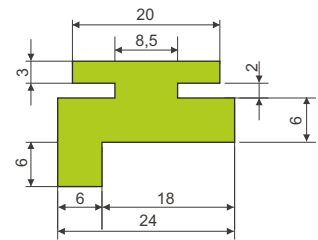

GUÍA PLANO INCL. A20

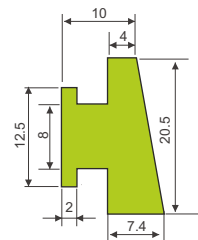

PARA PERFILES EN OTRAS
DIMENSIONES ENVIAR DETALLES

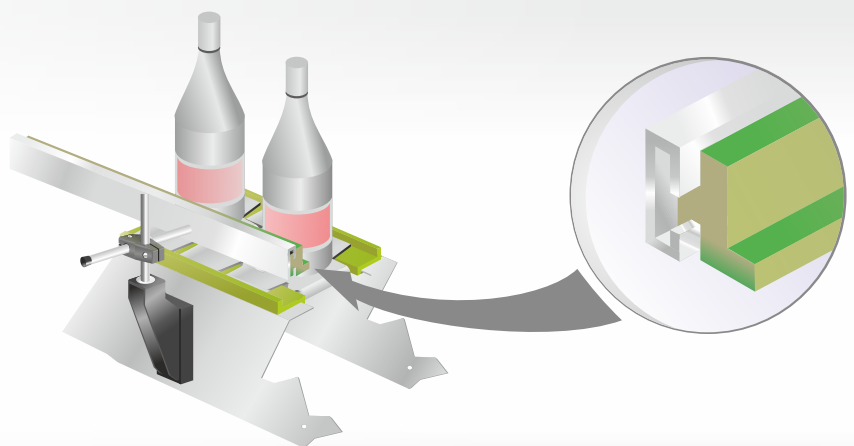

PIEZA	DESC.	PESO	PACK
255	24X12	347 g	T
254	24X6	220 g	
256	24X6L	257 g	
517	BARANDA C5	560 g	
1311	PL. INCL. A20	120 g	

REFERENCIAS	R-ROLLO T-TRAMO
VENTA	METRO
COLOR	EL COLOR DEL PERFILVARIA SEGÚN EL MODELO
MATERIALES	STD B2602 / V2600 / N2601
OPCIONES A PEDIDO	N - TERUAN 2820 X - TEUVAX 1828 E - ETADIM 1281

ESTOS PERFILES PUEDEN FABRICARSE EN
4 DIFERENTES CALIDADES:
THESE PROFILES CAN BE MANUFACTURED
IN 4 DIFFERENT QUALITIES:

Baranda - Side Guide

Perfiles Baranda Extra Side Guide

LOS COLORES SON A MODO DE EJEMPLO.

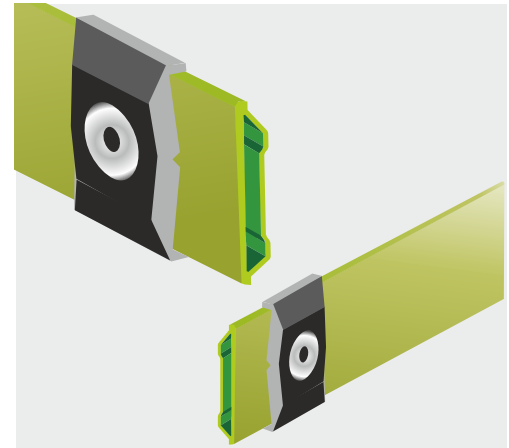

H 165x38.1

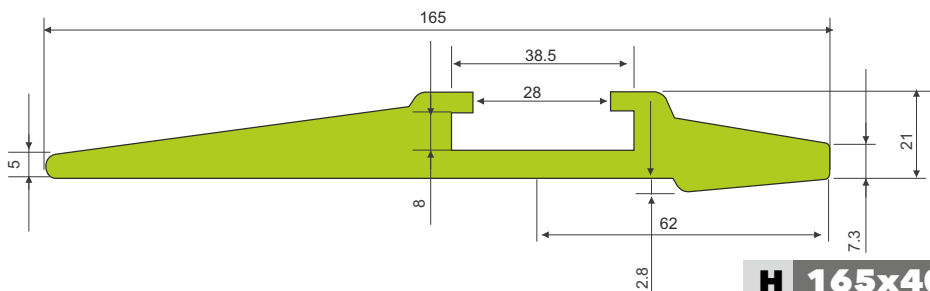

H 165x40

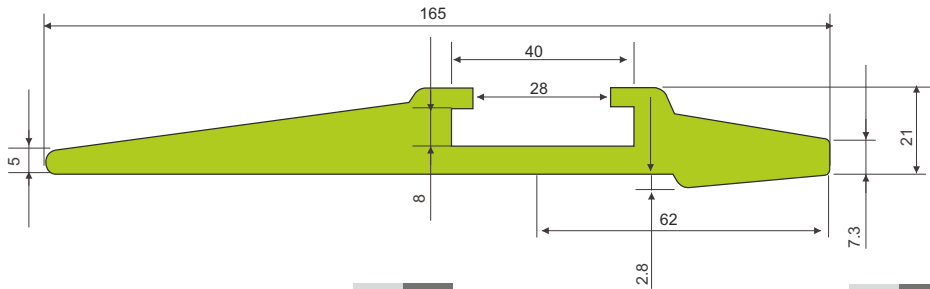

H 78

H 87

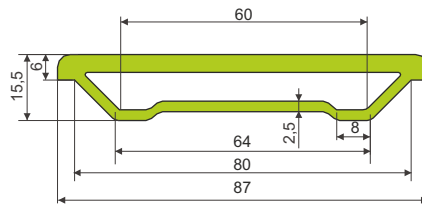
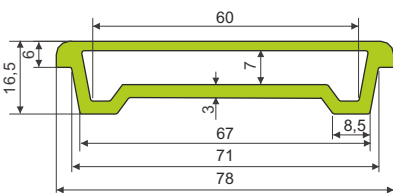

PIEZA	DESC.	PESO	PACK
282	H 78	457 g	T
281	H 87	505 g	
1856	H165x38	1530 g	
1700	H165x40	1530 g	

REFERENCIAS	R-ROLLO T-TRAMO
VENTA	METRO
COLOR	EL COLOR DEL PERFILVARIA SEGÚN EL MODELO
MATERIALES	STD B2602 / V2600 / N2601
OPCIONES A PEDIDO	N - TERUAN 2820 X - TEUVAX 1828 E - ETADIM 1281

DEJAR ENTRE EL TAPÓN Y EL TREFILADO PLANO, UNA DISTANCIA SUFICIENTE PARA LA CONTRACCIÓN LINEAL QUE EXPERIMENTA EL MATERIAL DE LAS GUÍAS A BAJAS TEMPERATURAS.

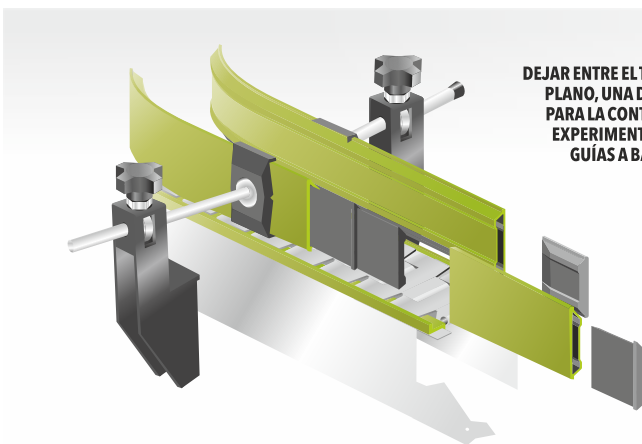
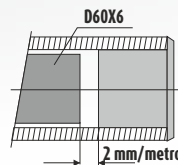

ESTOS PERFILES PUEDEN FABRICARSE EN 4 DIFERENTES CALIDADES:
THESE PROFILES CAN BE MANUFACTURED IN 4 DIFFERENT QUALITIES:

Cadena - Chain

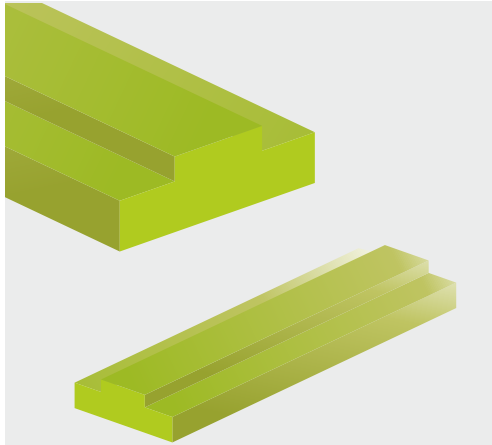

Para Cadena De Rodillo

Roller Chain Guide

LOS COLORES SON A MODO DE EJEMPLO.

CADENA RODILLO 1/2

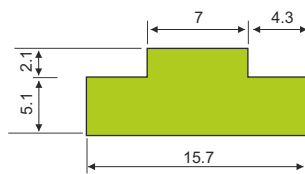

CADENA RODILLO 5/8

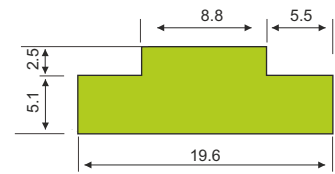

CADENA RODILLO 3/4

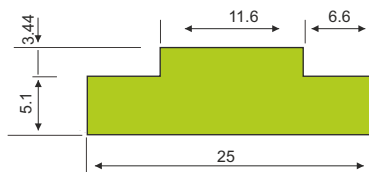

PARA PERFILES EN OTRAS
DIMENSIONES ENVIAR DETALLES

PIEZA ESPEC. DESC. PESO

1316	PERFIL	1/2"	100 g
1317	PARA	5/8"	110 g
1318	CADENA	3/4"	160 g

REFERENCIAS

R-ROLLO
T-TRAMO

VENTA

METRO

COLOR

EL COLOR DEL PERFIL VARIA
SEGÚN EL MODELO

MATERIALES

STD B2602 / V2600 / N2601

OPCIONES A PEDIDO

N - TERUAN 2820
X - TEUVAX 1828
E - ETADIM 1281

ESTOS PERFILES PUEDEN FABRICARSE EN
4 DIFERENTES CALIDADES:
THESE PROFILES CAN BE MANUFACTURED
IN 4 DIFFERENT QUALITIES:

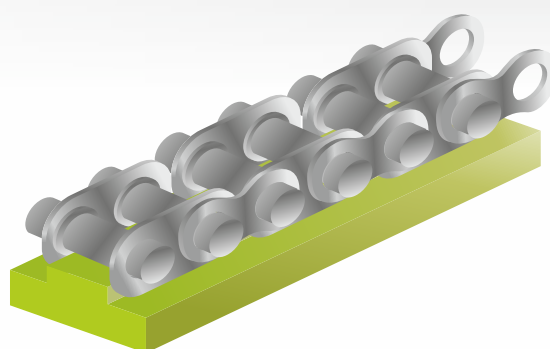

Cónicos - Conic

Perfiles Tipo Cónicos

Profiles Conic

LOS COLORES SON A MODO DE EJEMPLO.

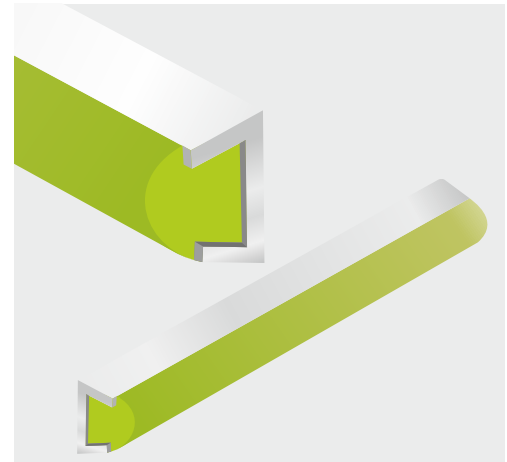

CÓNICO SEMIESFÉRICO

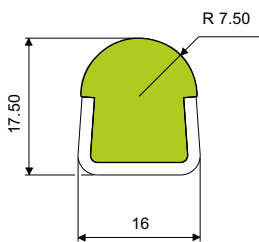

CÓNICO PLANO

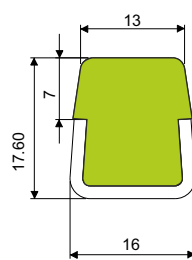

CÓNICO SALVA ETIQUETAS

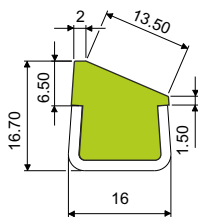

CÓNICO NEUMÁTICO

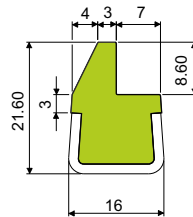

PIEZA	DESCRIPCIÓN	PACK
1200	SEMIESFÉRICO RESP. INOX.	T
1231	PLANO RESP. INOX.	
1201	SALVA ETIQUETAS RESP. INOX.	
1205	MEUMÁTICO RESP. INOX.	

PARA PERFILES EN OTRAS
DIMENSIONES ENVIAR DETALLES

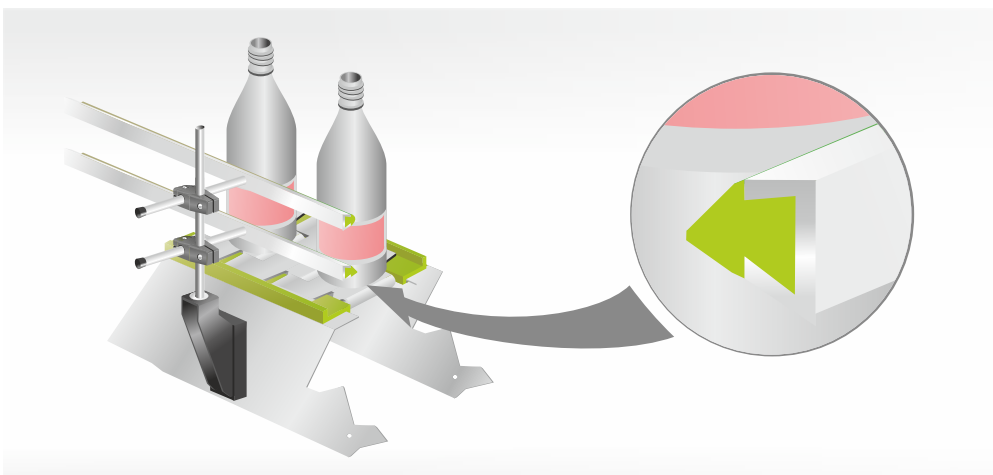

ESTOS PERFILES PUEDEN FABRICARSE EN
4 DIFERENTES CALIDADES:
THESE PROFILES CAN BE MANUFACTURED
IN 4 DIFFERENT QUALITIES:

Rectangular-Rectangular

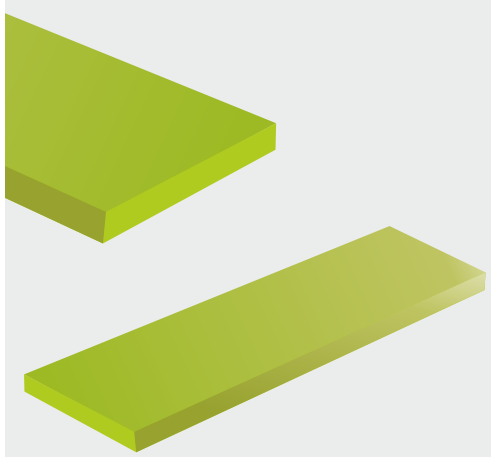

Perfiles Rectangulares

Profile Rectangular

LOS COLORES SON A MODO DE EJEMPLO.

TIPO RECTANGULAR

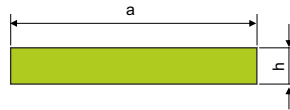

PIEZA	DESC.	PESO	PACK
258	32x3	93 g	
259	45x3	129 g	
260	20x4	76 g	
261	30x4	114 g	
264	45x4	171 g	
265	50x4	190 g	
266	55x4	209 g	
267	60x4	230 g	R
268	70x4	266 g	
284	90x4	342 g	
269	20x5	95 g	
270	50x6	285 g	
283	40x3	114 g	
262	35x4	133 g	
257	20x3	57 g	
263	40x4	152 g	
271	60x6	342 g	T
272	50x8	380 g	R
1430	53x3	160 g	T
1278	40x10	400 g	
1358	30x10	300 g	
1431	32x8	260 g	
1893	1"1/4x1/4		
1894	1"1/2x1/4		
1895	2"x1/4		

REFERENCIAS

R-ROLLO
T-TRAMO

VENTA

METRO

COLOR

EL COLOR DEL PERFIL VARIA SEÚN EL MODELO

MATERIALES

STD B2602 / V2600 / N2601

OPCIONES A PEDIDO

N - TERUAN 2820:
X - TEUVAX 1828:
E - ETADIM 1281:

PARA PERFILES EN OTRAS
DIMENSIONES ENVIAR DETALLES

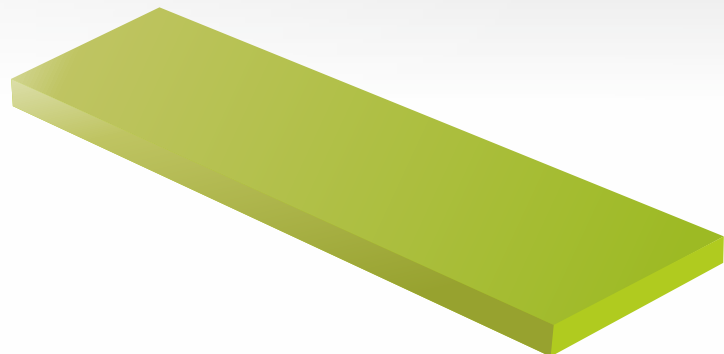

ESTOS PERFILES PUEDEN FABRICARSE EN
4 DIFERENTES CALIDADES:
THESE PROFILES CAN BE MANUFACTURED
IN 4 DIFFERENT QUALITIES:

Cepillos - Neumatic

Perfiles Tipo Cepillos Profiles Neumatic

LOS COLORES SON A MODO DE EJEMPLO.

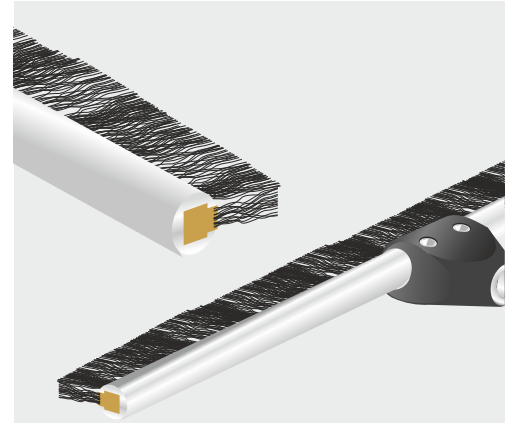

ALUMINIO c/ CERDA 12

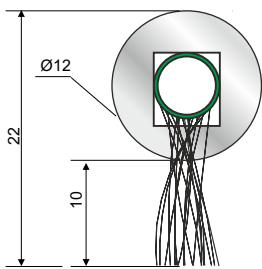

ALUMINIO D12

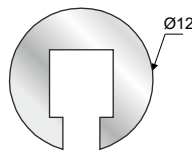

ALUMINIO c/ CERDA 18

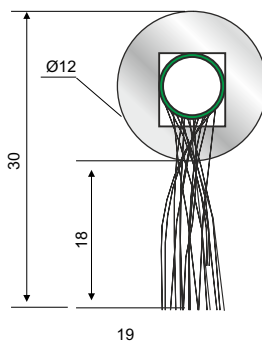

ALUMINIO c/ CERDA 28

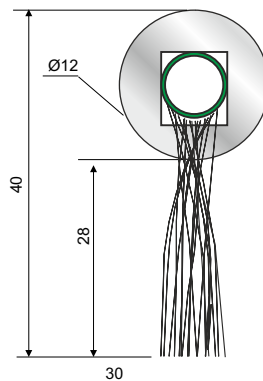

PARA PERFILES EN OTRAS
DIMENSIONES ENVIAR DETALLES

PIEZA	DESCRIPCIÓN	PACK
1172	PERFIL ALUMINIO D12	T
967	ALT/SEP 12 mm	
1305	ALT/SEP 18 mm	
1306	ALT/SEP 28 mm	

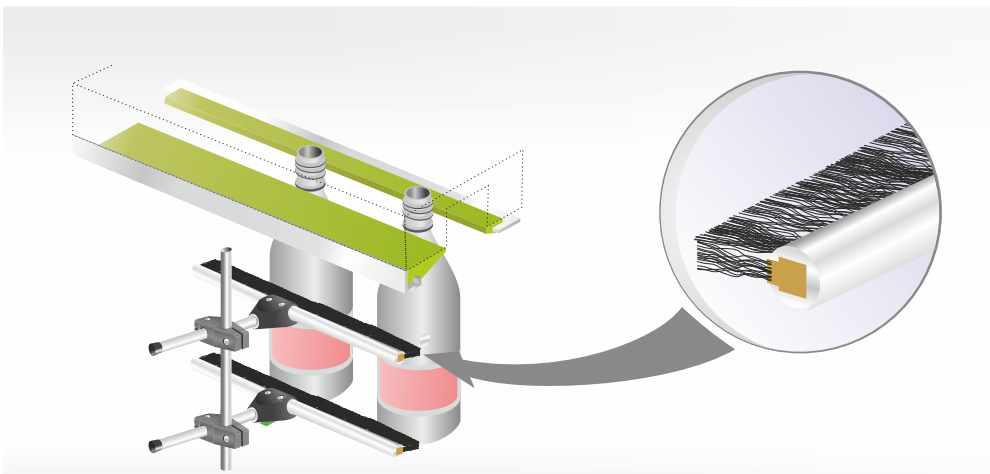

ESTOS PERFILES PUEDEN FABRICARSE EN
4 DIFERENTES CALIDADES:
THESE PROFILES CAN BE MANUFACTURED
IN 4 DIFFERENT QUALITIES:

Varios - Several

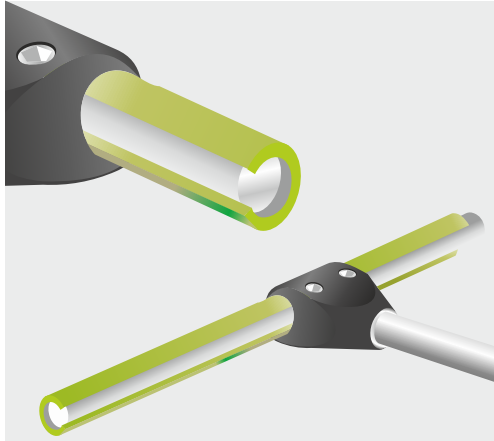

Perfiles Varios

Several

LOS COLORES SON A MODO DE EJEMPLO.

MEDIA CAÑA 5/16

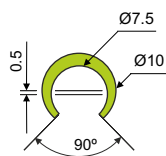

MEDIA CAÑA 1/2

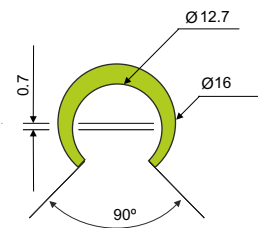

PIEZA	DESCRIPCIÓN	PACK
994	MEDIA CAÑA 1/2	R
995	MEDIA CAÑA 5/16	
250	TT 20x10	
251	TT 30x10	

TT 20x10

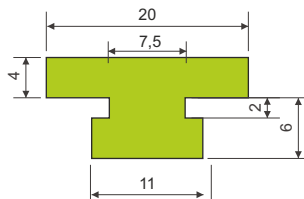

TT 30x10

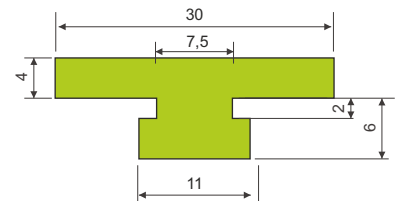

PARA PERFILES EN OTRAS
DIMENSIONES ENVIAR DETALLES

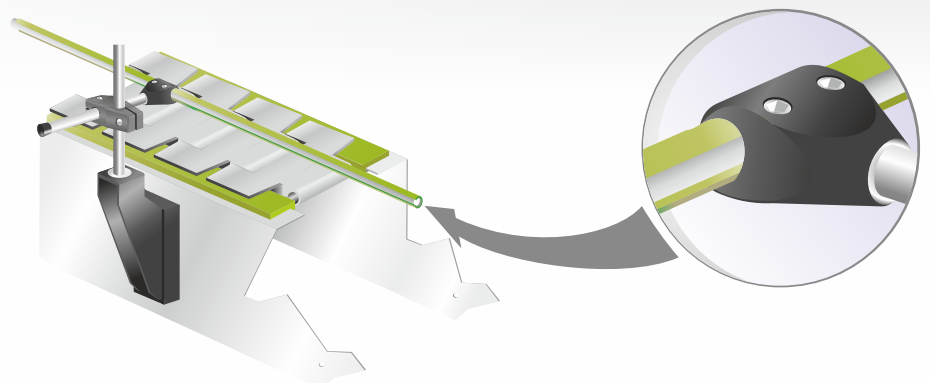

ESTOS PERFILES PUEDEN FABRICARSE EN
4 DIFERENTES CALIDADES:
THESE PROFILES CAN BE MANUFACTURED
IN 4 DIFFERENT QUALITIES:

Varios - Several

Perfiles Varios Several

LOS COLORES SON A MODO DE EJEMPLO.

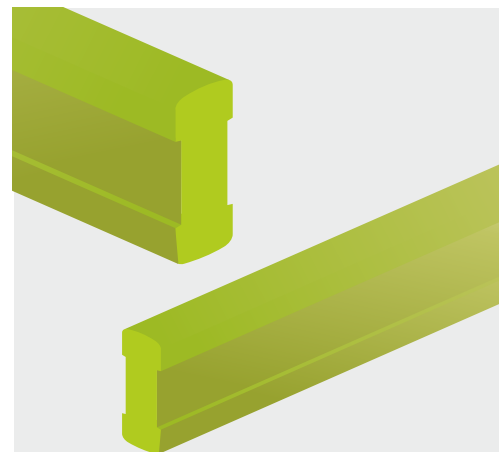

PERFIL BANDA DE RETORNO

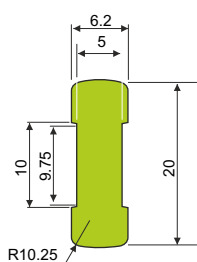

PERFIL BANDA CURVA

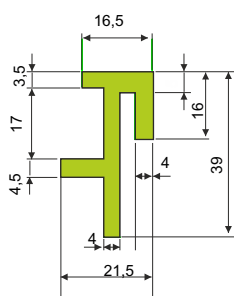

PERFIL BANDA CURVA c/ TAB

PERFIL DISCONTINUADO, REEMPLAZADO POR PERFIL BARANDA CURVA C/TAB

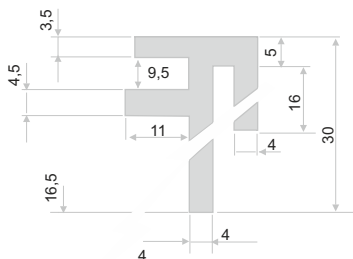

PERFIL BANDA CURVA c/ TAB

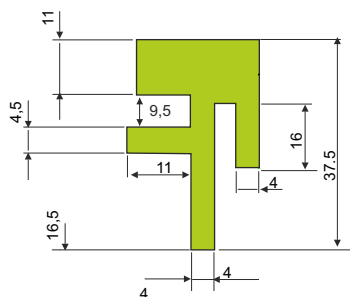

PARA PERFILES EN OTRAS DIMENSIONES ENVIAR DETALLES

PIEZA	DESCRIPCIÓN	PACK
947	DE RETORNO	
1176	BARANDA CURVA C/TAB	T
1177	BARANDA CURVA	

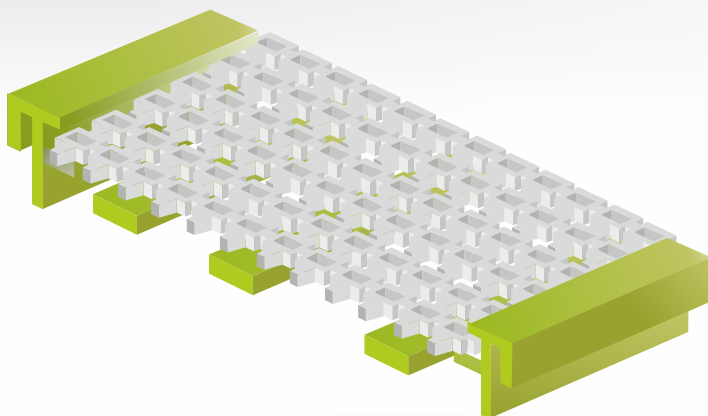

ESTOS PERFILES PUEDEN FABRICARSE EN 4 DIFERENTES CALIDADES:
THESE PROFILES CAN BE MANUFACTURED IN 4 DIFFERENT QUALITIES:

Varios - Several

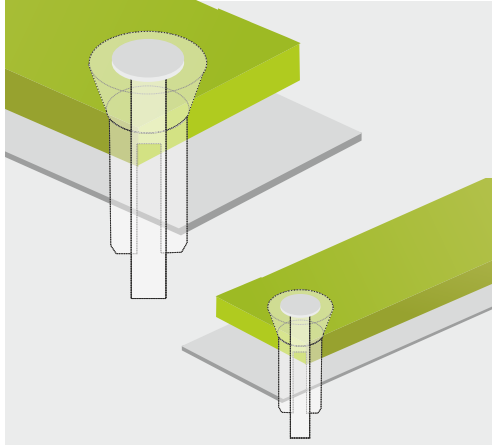

Perfiles Varios

Several

LOS COLORES SON A MODO DE EJEMPLO.

PERFIL REMACHE

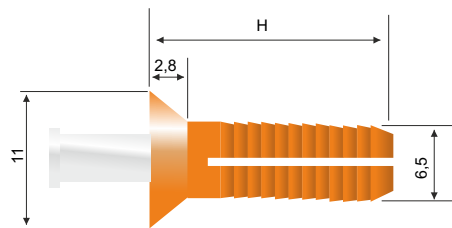

PIEZA	DESCRIP.	H	PACK
1179	REM. DE FIJACIÓN	19mm	
1180	REM. DE FIJACIÓN	25mm	
1181	REM. DE FIJACIÓN	38mm	

PARA PERFILES EN OTRAS
DIMENSIONES ENVIAR DETALLES

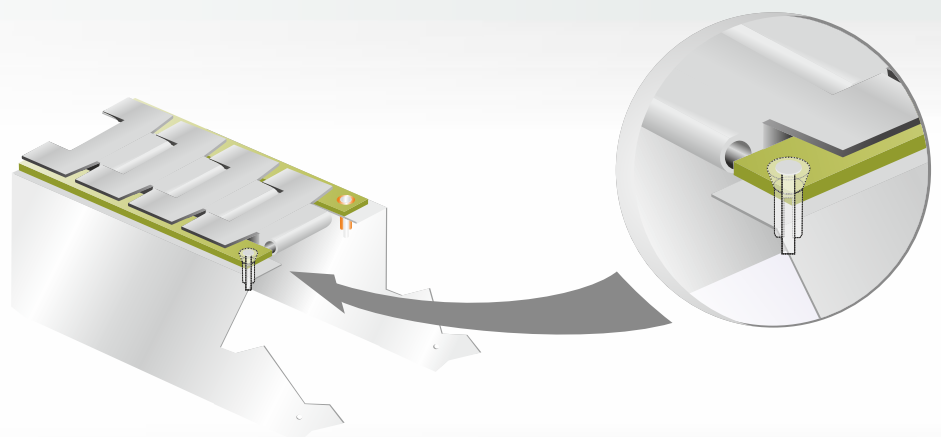

ESTOS PERFILES PUEDEN FABRICARSE EN
4 DIFERENTES CALIDADES:
THESE PROFILES CAN BE MANUFACTURED
IN 4 DIFFERENT QUALITIES: